

PART 5079
19 GA.—16 GA.—.090 ALUM
CUT LENGTHS AVAILABLE

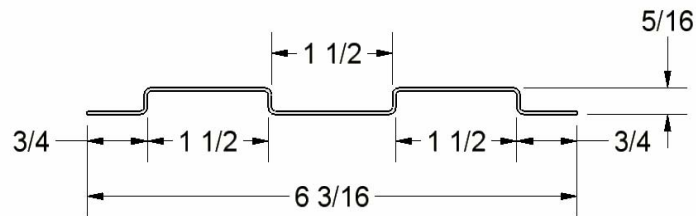

PART 5222
DOUBLE BELT RAIL
19 GA.

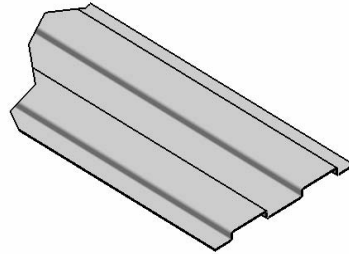
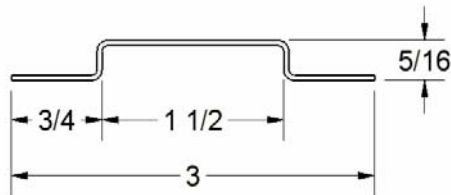
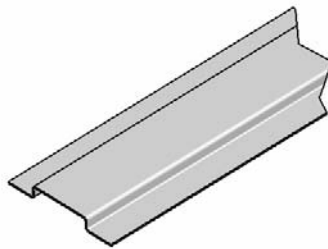

PART 5128
SINGLE BELT RAIL
19 GA.

OTHER SIZES & MATERIALS ARE AVAILABLE ON REQUEST

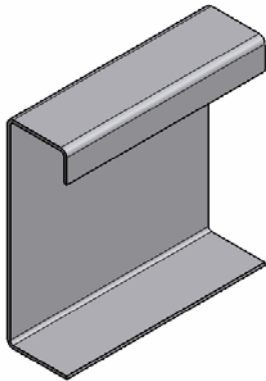

PART 5345
SOLID SIDE W/O TARP RAIL
14 GA.
MAXIMUM HEIGHT 45"
MAXIMUM LENGTH 144"

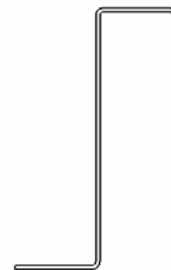
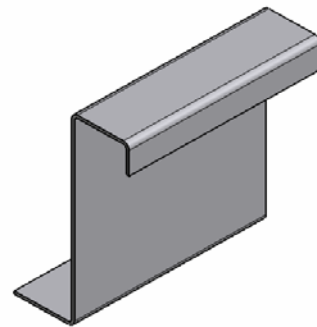

PART 5346
SOLID SIDE WITH TARP RAIL
14 GA.
MAXIMUM HEIGHT 44"
MAXIMUM LENGTH 144"

OTHER SIZES & MATERIALS ARE AVAILABLE ON REQUEST

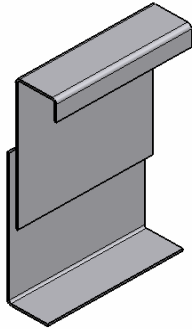

PART 5347
TWO PCS. SIDE W/O TARP RAIL
14 GA.
HEIGHT TO CUSTOMER SPECIFICATIONS
MAXIMUM LENGTH 144"

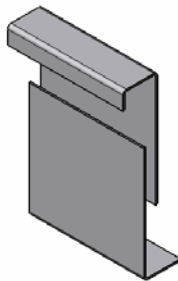
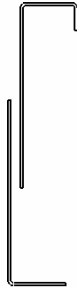

PART 5348
TWO PCS. SIDE WITH
TARP RAIL
14 GA.
HEIGHT TO CUSTOMER SPECIFICATIONS
MAXIMUM LENGTH 144



OTHER SIZES & MATERIALS ARE AVAILABLE ON REQUEST

STEEL GRAIN SIDES

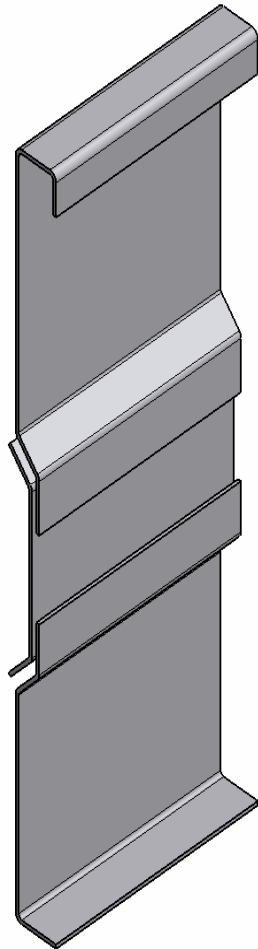

PART 5349
VENT SIDE W/O TARP RAIL
14 GA.
HEIGHT TO CUSTOMER
SPECIFICATIONS
MAXIMUM LENGTH 144"

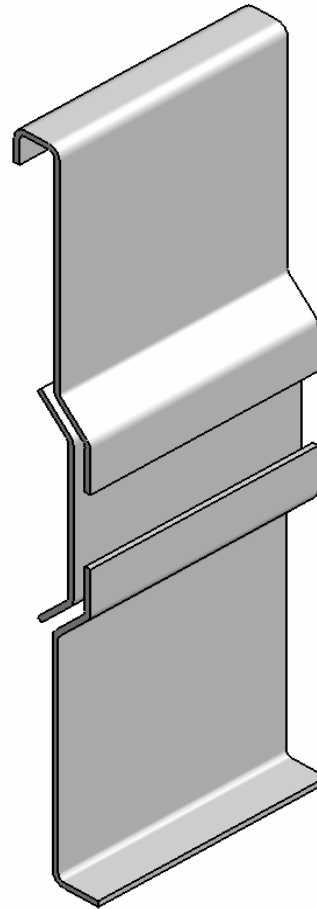

PART 5350
VENT SIDE WITH TARP RAIL
14 GA.
HEIGHT TO CUSTOMER
SPECIFICATIONS
MAXIMUM LENGTH 144"

OTHER SIZES & MATERIALS ARE AVAILABLE ON REQUEST

V EMOSS PANELS

THESE PARTS CAN BE
MADE TO CUSTOMER
SPECIFICATIONS &
CONFIGURATION.

MAXIMUM LENGTH 120"
MAXIMUM 14 GA.

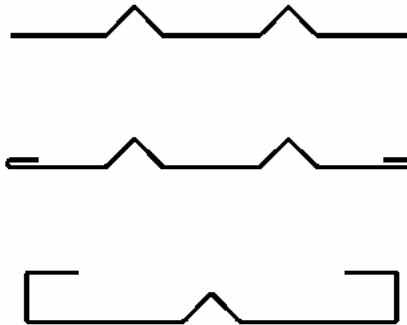
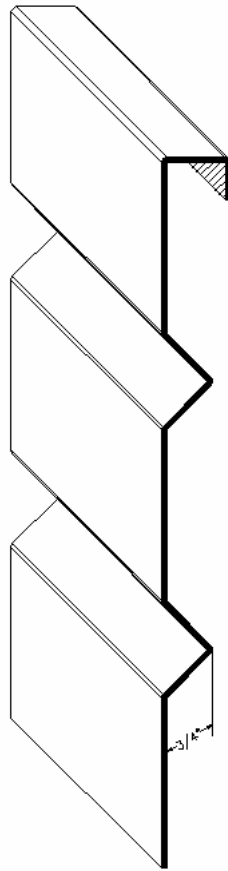

OTHER SIZES & MATERIALS ARE AVAILABLE ON REQUEST